

**DYNATECT**<sup>®</sup>  
DYNAMIC EQUIPMENT PROTECTION

***thodacon***<sup>®</sup>

## **POLYCLUTCH<sup>®</sup> DESIGN GUIDE**

*Mechanical, Pneumatic, Fixed, and Adjustable Clutches*



Polyclutch<sup>®</sup> precision slip clutches provide smooth breakaway, repeatable torque control, continuous slip, and a long operating life of 20 to 30 million revolutions in slip condition.

# POLYCLUTCH® SLIP CLUTCH OVERVIEW

## POLYCLUTCH ELIMINATES STICTION

Dynatect's clutches are manufactured utilizing a proprietary technique resulting in accurate and repeatable torque, smooth breakaway, and continuous slip durability. Stiction is the static friction that needs to be overcome to enable relative motion of stationary objects in contact. The elimination of static friction or

"stiction" is a result of breakaway torque that is less than running torque, providing predictable performance and characteristics. Dynatect's burn-in process ensures that all Polyclutch® slip clutches perform consistently right out of the box, with no break-in period required.

### Key Benefits

- Smooth breakaway and continuous slip
- Accurate, repeatable cushioned torque
- Long life of 20-30 million cycles in slip condition
- Torque range from 0.5 lb-in to 1000 lb-in
- Fixed, adjustable and custom designs
- Clutches are bi-directional
- No break-in period required
- No lubrication needed

### Limitations

- Maximum 1.25 inch shaft size
- Not to be used as a universal joint or a spring coupler
- Does not de-couple at overload
- Cannot be exposed to radiation
- If slip clutch would be directly exposed to weather or wash down, contact Dynatect to discuss

### A Great Alternative To...

- Servo-motors: our solution costs less
- Magnetic clutches: smaller, less expensive
- Ball detent: no clicking, no reset required
- Torque limiters: consistent repeatability, continuous slip
- Electronic protection only: added mechanical safety in electronically controlled systems



*Polyclutch® is made in the USA*

## DESIGN FUNCTIONS AND APPLICATIONS

Polyclutch slip clutches can slip continuously or intermittently for 20 to 30 million cycles. This opens up many design engineering options including...

### Overload Protection

Protect machinery and operator. Clutch will slip when mechanism is jammed. Motion will continue when impediment is removed.

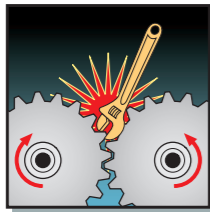

### Soft Starts/ Cushioned Stops

Inertia makes clutch slip when starting and/or stopping. Results in less shock throughout the system. Ideal for slip at the end of stroke. No sudden shock on sensitive paper, film, wire, thread, etc.

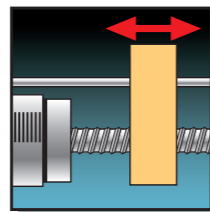

### Positioning Hinge

Hold lid or cover at any position. Fingertip control. Combine with one way clutch for free movement in one direction. Ideal for hinges when requiring smooth movement of lids, covers, doors, screens, medical equipment, light fixtures, etc.

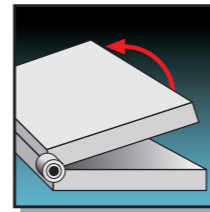

### Tension Control

Maintain constant tension while winding or unwinding wire, paper, film, thread, etc. Slip clutch automatically compensates for changes in speed and diameter. Pneumatic clutch can change tension during operation. Smooth, accurate starting/stopping of conveyors, indexing mechanisms, linear actuators, take-up reels, printers, etc.

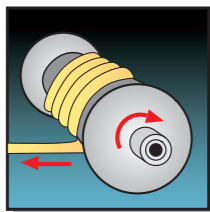

### Torque Control

Screw bottle caps, screws, controls, etc., to correct torque setting. Combine with one way clutch to slip at rated torque in one direction and freewheel or positive drive in other direction. Repeatable, accurate torque for capping machines, fastener driving, valve control, etc.

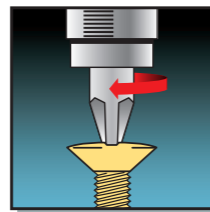

### Force Control

Push product against gate with constant force. Remove gate and move to next position. No damage to product or conveyor – clutch does all the slipping. Also used for overload protection when jammed and for indexing the conveyor.

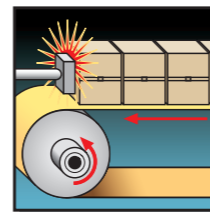

# APPLICATION EXAMPLES

## Automated Kiosks

Polyclutch® slip clutches are an integral part of many retail kiosks. As shown in this photo, a slip clutch is used to protect the sensitive drive mechanisms of these automated machines.

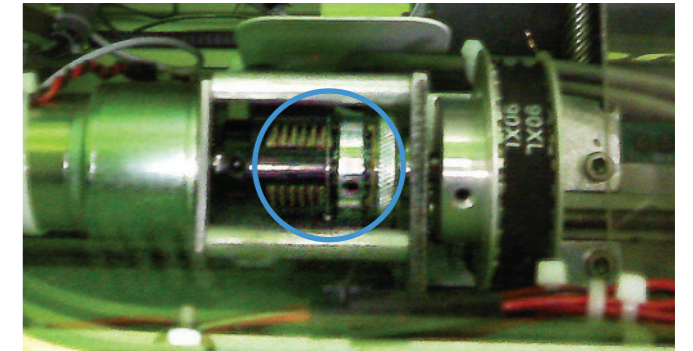

## Bottle Capping

Polyclutch adjustable slip clutches control the precise amount of torque to tighten bottle caps, without wear or breakage, in this capping line application. All the slippage is in the clutch, with no appreciable wear.

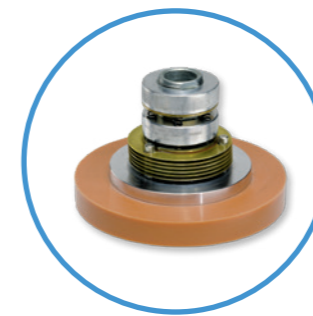

## Disabled Access Systems

A Polyclutch slip clutch provides safety in many disabled access systems, as seen in this photo, where it is being used for overload protection in an automated door opener.

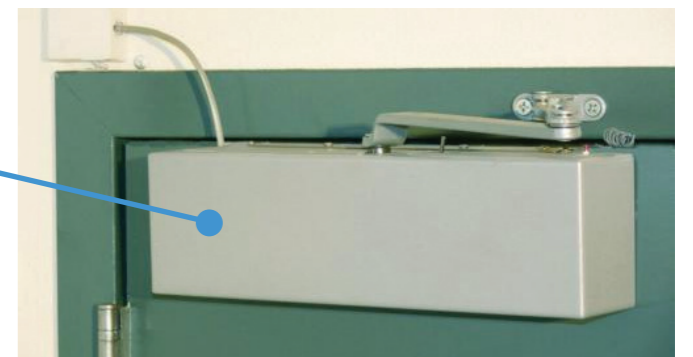
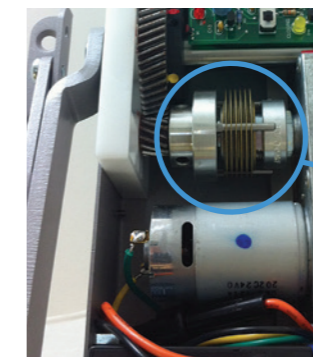

## Printers and Labelers

A slip clutch acts as a continuous drag brake to meet the specific torque requirement for this unwind/rewind system application in a bar code printer. Other applications apply constant tension to film, wire, thread, paper, etc.



# APPLICATION EXAMPLES

SEE PAGE 18 FOR ADDITIONAL EXAMPLES



**Conveyors (left)**  
Polyclutch® slip clutches offer an added level of safety and protection to both the machine and its operators.

**Ice-Dispensing Machines (right)**  
A Polyclutch slip clutch prevents overload to the drive mechanism during the forming and dispensing of ice cubes.



**Military and Law Enforcement Robots (left)**  
An industry leader in defense robotics utilized two Polyclutch slip clutches in each robot arm for overload protection.

**Retail Vending Kiosks (right)**  
A Polyclutch protects this machine against any type of overload or jamming during the process of dispensing a DVD



**MRI Beds (left)**  
A slip clutch adds mechanical safety to moving MRI beds.

**Label Printer (right)**  
Polyclutch slip clutches are the perfect solution for adding just the right amount of tension to any reel or spool without having to worry about the tension varying over time or wearing out prematurely.



# SERIES 16 | MECHANICAL SLIP CLUTCHES

OUR MOST COMPACT MODEL FEATURES BIG TORQUE IN A SMALL PACKAGE

## ADJUSTABLE

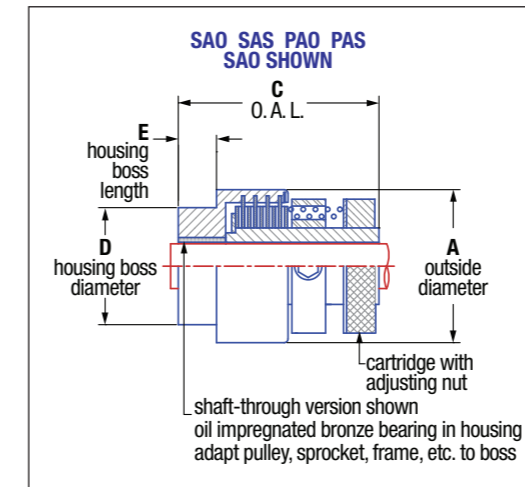

## FIXED FACTORY SET – NON ADJUSTABLE

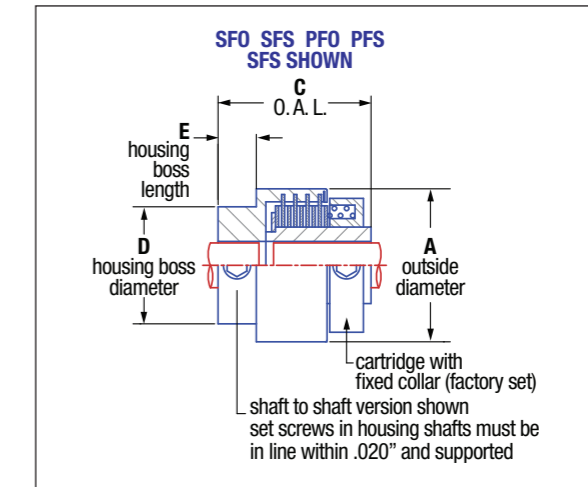

## END VIEW TYPICAL

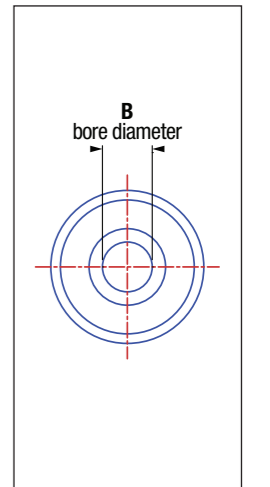

MODEL NO.	A inches (mm)	B STD.	B MAX.	C inches (mm)	D inches (mm)	E inches (mm)	CAPACITY @ 50 RPM		FRICTION SURFACES
		inches (mm)	inches (mm)				lb-in (Nm)	Watts	
SFS 16 & SFO 16	1.00 (25.4)	.250 (8)	.375 (9)	1.00 (25.40)	.760 (19.30)	.25 (6.35)	10 (1.2)	6	8
SAS 16 & SAO 16	1.00 (25.4)	.250 (8)	.375 (9)	1.31 (33.27)	.760 (19.30)	.25 (6.35)	10 (1.2)	6	8
PFS 16 & PFO 16	1.00 (25.4)	.250 (8)	.375 (9)	.78 (19.81)	.760 (19.30)	.25 (6.35)	2 (.3)	1	2
PAS 16 & PAO 16	1.00 (25.4)	.250 (8)	.375 (9)	1.06 (26.92)	.760 (19.30)	.25 (6.35)	2 (.3)	1	2

## PART NUMBER EXAMPLE

See page 16 for part number identification.

**P F S 16 - 4 - 4 T\***

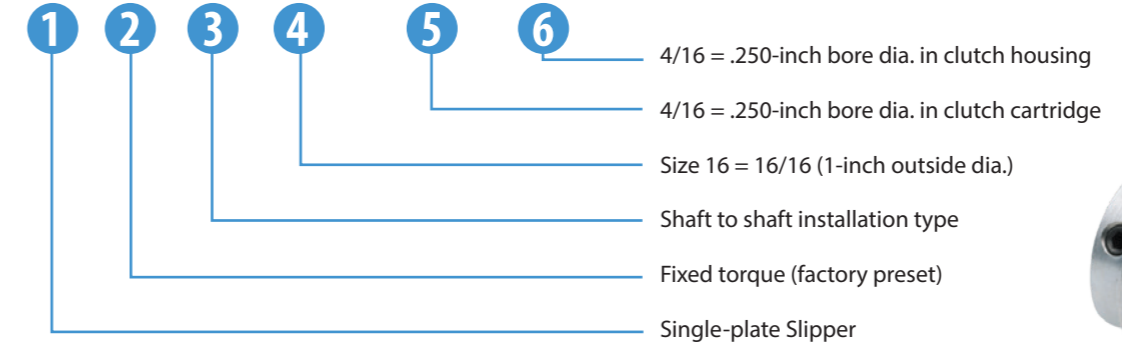

\*T = Preset Torque Value, customer-specified



## QUOTE REQUEST FORM: SEE PAGE 17

To see how Polyclutch® slip clutches operate, visit [dynatect.com/clutch-video](http://dynatect.com/clutch-video)

# SLIPPER | MECHANICAL SLIP CLUTCHES

The Polyclutch® Slipper controls torque for intermittent, continuous or overload slip. It contains a number of brass plates interfaced with long life friction material. Soft springs maintain pressure on the friction plates, assuring constant torque. An adjacent component of your mechanism can often be used as the clutch housing reducing overall cost or space concerns. Torque control in one direction can be achieved by combining with our one-way clutch.

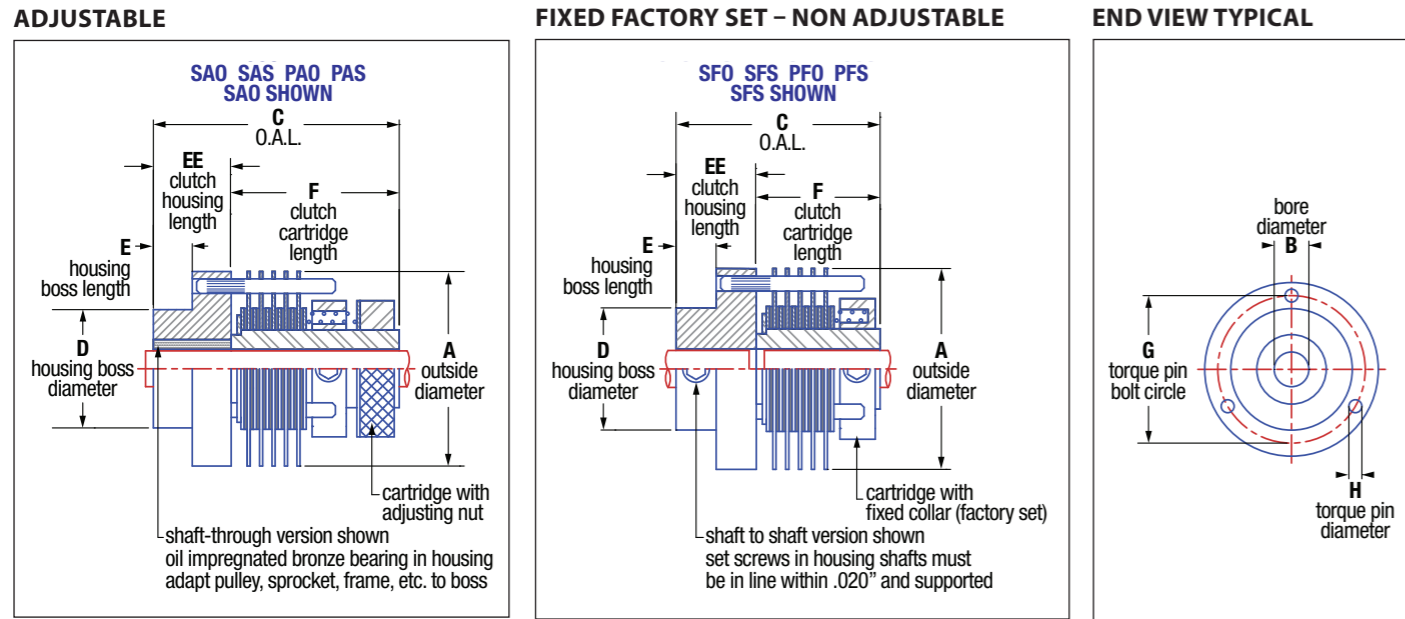

**NOTE:** Multi-plate clutches shown. Single-plate clutch supplied with one set of friction plates and pads.

### PART NUMBER EXAMPLE

See page 16 for part number identification.

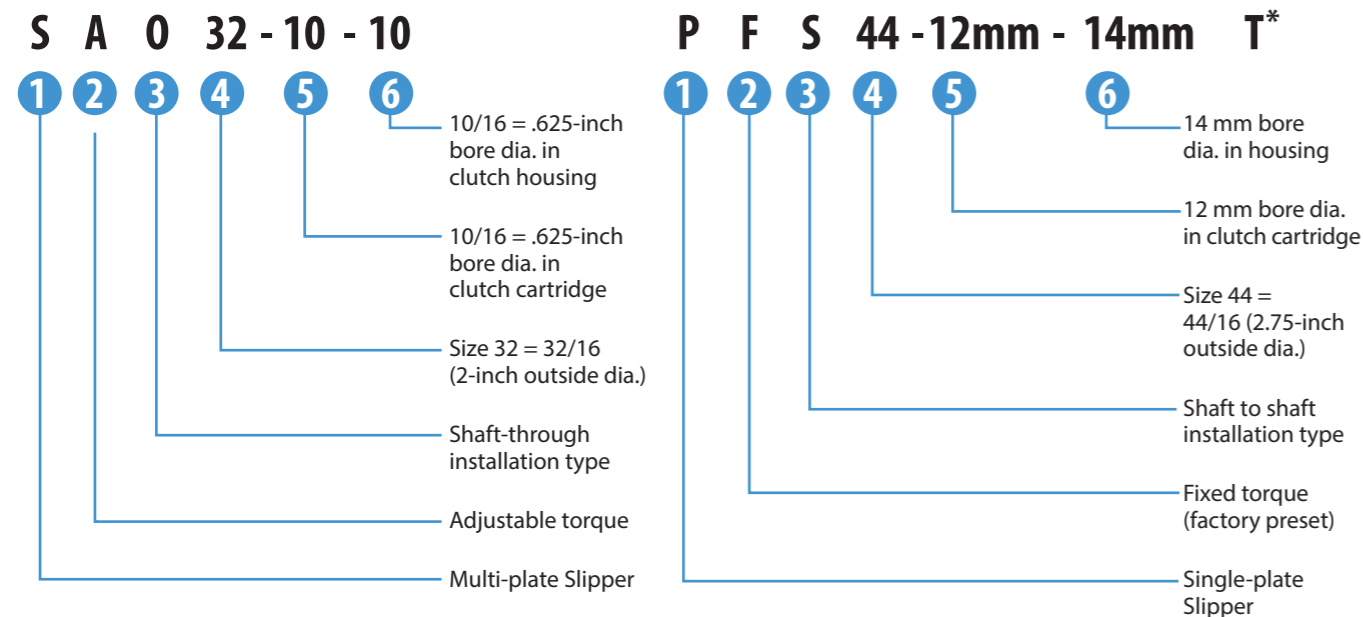

\*T = Preset Torque Value, customer-specified

# SLIPPER | SPECIFICATIONS

MODEL NO.	A inches (mm)	B* STD.	B MAX.	C inches (mm)	D inches (mm)	E inches (mm)	EE inches (mm)	F inches (mm)	G inches (mm)	H inches (mm)	CAPACITY @ 50 RPM		FRICTION SURFACES
		inches (mm)	inches (mm)								lb-in (Nm)	Watts	
SFS 20 & SFO 20	1.25 (31.75)	.250 (8)	.375 (10)	1.19 (30.2)	.760 (19.30)	.25 (6.35)	.50 (12.70)	.69 (17.50)	1.062 (26.97)	.094 (2.38)	12 (1.35)	6	8
SAS 20 & SAO 20	1.25 (31.75)	.250 (8)	.375 (10)	1.50 (38.1)	.760 (19.30)	.25 (6.35)	.50 (12.70)	1.00 (25.40)	1.062 (26.97)	.094 (2.38)	12 (1.35)	6	8
SFS 24 & SFO 24	1.50 (38.10)	.375 (10)	.500 (13)	2.00 (50.08)	1.010 (25.65)	.38 (9.65)	.75 (19.05)	1.25 (31.75)	1.312 (33.32)	.125 (3.18)	25 (2.82)	15	12
SAS 24 & SAO 24	1.50 (38.10)	.375 (10)	.500 (13)	2.50 (63.5)	1.010 (25.65)	.38 (9.65)	.75 (19.05)	1.75 (44.50)	1.312 (33.32)	.125 (3.18)	25 (2.82)	15	12
SFS 32 & SFO 32	2.00 (50.80)	.500 (12)	.625 (16)	2.31 (58.7)	1.385 (35.18)	.50 (12.70)	1.00 (25.40)	1.31 (33.30)	1.672 (42.47)	.188 (4.78)	50 (5.65)	30	12
SAS 32 & SAO 32	2.00 (50.80)	.500 (12)	.625 (16)	2.87 (72.9)	1.385 (35.18)	.50 (12.70)	1.00 (25.40)	1.88 (47.80)	1.672 (42.47)	.188 (4.78)	50 (5.65)	30	12
SFS 44 & SFO 44	2.75 (69.85)	.500 (12)	.625 (16)	2.31 (58.7)	1.635 (41.53)	.50 (12.70)	1.00 (25.40)	1.31 (33.30)	2.375 (60.33)	.188 (4.78)	75 (8.47)	43	12
SAS 44 & SAO 44	2.75 (69.85)	.500 (12)	.625 (16)	2.87 (72.9)	1.635 (41.53)	.50 (12.70)	1.00 (25.40)	1.88 (47.80)	2.375 (60.33)	.188 (4.78)	75 (8.47)	43	12
SFS 48 & SFO 48	3.00 (76.20)	.625 (16)	1.00 (25)	3.00 (76.2)	1.760 (44.70)	.50 (12.70)	1.00 (25.40)	2.00 (50.80)	2.625 (66.80)	.250 (6.35)	100 (11.29)	55	12
SAS 48 & SAO 48	3.00 (76.20)	.625 (16)	1.00 (25)	3.50 (88.9)	1.760 (44.70)	.50 (12.70)	1.00 (25.40)	2.50 (63.50)	2.625 (66.80)	.250 (6.35)	100 (11.29)	55	12
PFS 20 & PFO 20	1.25 (31.75)	.250 (8)	.375 (10)	.78 (19.8)	.760 (19.30)	.19 (4.83)	.31 (7.87)	.47 (11.90)	1.062 (26.97)	.094 (2.38)	2.5 (0.28)	1	2
PAS 20 & PAO 20	1.25 (31.75)	.250 (8)	.375 (10)	1.06 (26.9)	.760 (19.30)	.19 (4.83)	.31 (7.87)	.75 (19.10)	1.062 (26.97)	.094 (2.38)	2.5 (0.28)	1	2
PFS 24 & PFO 24	1.50 (38.80)	.375 (10)	.500 (13)	1.07 (27.0)	1.010 (25.65)	.19 (4.83)	.38 (9.65)	.69 (17.50)	1.312 (33.32)	.125 (3.18)	4 (0.45)	2	2
PAS 24 & PAO 24	1.50 (38.80)	.375 (10)	.500 (13)	1.32 (33.5)	1.010 (25.65)	.19 (4.83)	.38 (9.65)	.94 (23.90)	1.312 (33.32)	.125 (3.18)	4 (0.45)	2	2
PFS 32 & PFO 32	2.00 (50.80)	.500 (12)	.625 (16)	1.22 (31.0)	1.385 (35.18)	.25 (6.35)	.50 (12.70)	.72 (18.30)	1.672 (42.47)	.188 (4.78)	8 (0.90)	5	2
PAS 32 & PAO 32	2.00 (50.80)	.500 (12)	.625 (16)	1.72 (43.7)	1.385 (35.18)	.25 (6.35)	.50 (12.70)	1.22 (31.00)	1.672 (42.47)	.188 (4.78)	8 (0.90)	5	2
PFS 44 & PFO 44	2.75 (69.85)	.500 (12)	.625 (16)	1.22 (31.0)	1.635 (41.53)	.25 (6.35)	.50 (12.70)	.72 (18.30)	2.375 (60.33)	.188 (4.78)	12 (1.35)	7	2
PAS 44 & PAO 44	2.75 (69.85)	.500 (12)	.625 (16)	1.72 (43.7)	1.635 (41.53)	.25 (6.35)	.50 (12.70)	1.22 (31.00)	2.375 (60.33)	.188 (4.78)	12 (1.35)	7	2
PFS 48 & PFO 48	3.00 (76.10)	.625 (16)	1.00 (25)	2.25 (57.15)	1.760 (44.70)	.50 (12.70)	1.0 (25.40)	1.25 (31.75)	2.625 (66.80)	.250 (6.35)	20 (2.26)	13	2
PAS 48 & PAO 48	3.00 (76.10)	.625 (16)	1.00 (25)	2.75 (69.85)	1.760 (44.70)	.50 (12.70)	1.0 (25.40)	1.75 (44.45)	2.625 (66.80)	.250 (6.35)	20 (2.26)	13	2

\*Bore diameters (Dimension B) other than standards shown are available up to the maximum diameter. Please note that torque capacities are only guidelines. Higher torques and speeds are possible depending on operating conditions. Consult factory for details.

### QUOTE REQUEST FORM: SEE PAGE 17.

To see how Polyclutch® slip clutches operate, visit [dynatect.com/clutch-video](http://dynatect.com/clutch-video)

# V-SERIES SLIPPER | MECHANICAL SLIP CLUTCHES

The V-Series Slipper provides torque control for driving, capping and other applications where thrust loads are applied. Its integrated ball bearing allows thrust loads up to 650 pounds without any effect on torque. Self-supporting hub design allows for easy installation; shaft-through support is not required. The V-Series slipper may be used for pulley applications; and its design allows rebuilding, if necessary.



END VIEW TYPICAL

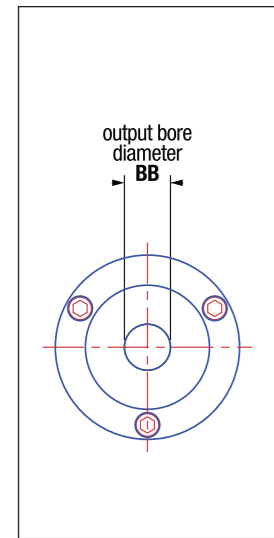

ADJUSTABLE

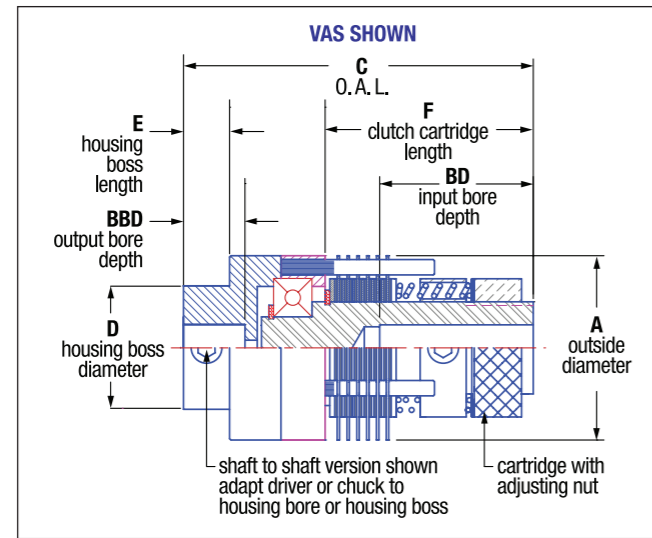

END VIEW TYPICAL

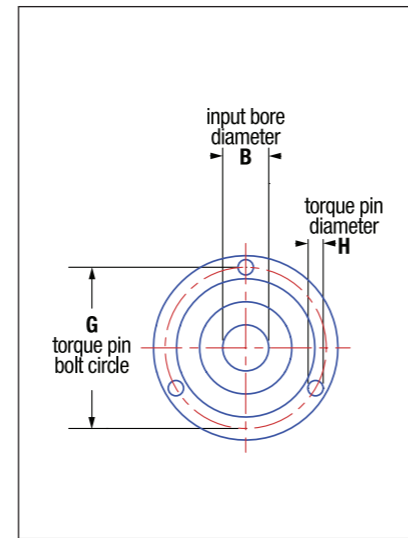

## PART NUMBER EXAMPLE

See page 16 for part number identification.

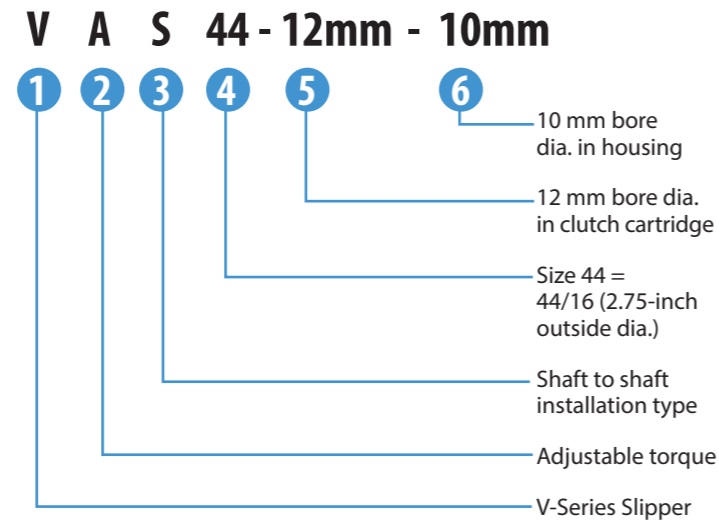
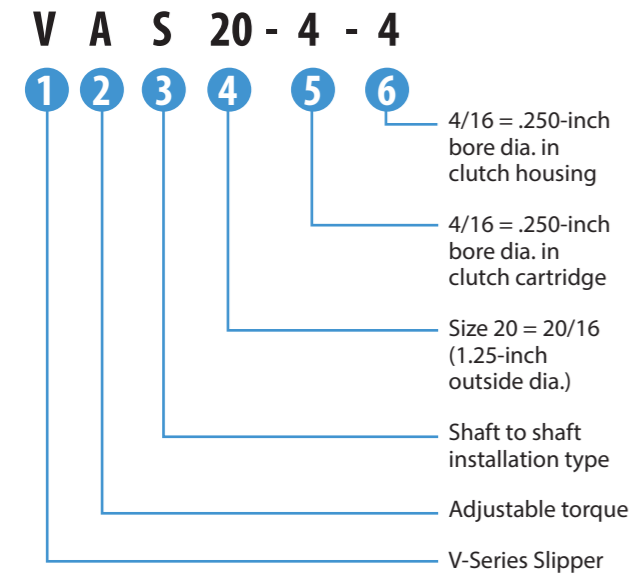

# V-SERIES SLIPPER | SPECIFICATIONS

## HORIZONTAL & VERTICAL INSTALLATION WITHOUT DRIVESHAFT MODIFICATIONS!

MODEL NO.	A inches (mm)	B* STD.	B MAX.	BD inches (mm)	BB** inches (mm)	BBD inches (mm)	C inches (mm)	+ .002 / - .000 inches (+.05 / -.00 mm)	E inches (mm)	F inches (mm)	G inches (mm)	H inches (mm)
		inches (mm)	inches (mm)					D inches (mm)				
VAS 20	1.25 (31.75)	.250 (8)	.375 (10)	.750 (19.05)	.250 (6.35)	.500 (12.7)	2.05 (52.07)	.750 (19.05)	.350 (8.89)	.98 (24.89)	1.062 (26.97)	.094 (2.39)
VAS 24	1.50 (38.10)	.375 (10)	.500 (13)	1.25 (31.75)	.250 (6.35)	.500 (12.7)	2.85 (72.39)	1.000 (25.40)	.375 (9.53)	1.69 (42.93)	1.312 (33.32)	.125 (3.19)
VAS 32	2.00 (50.80)	.500 (12)	.625 (16)	1.25 (31.75)	.250 (6.35)	.500 (12.7)	3.00 (76.20)	1.375 (34.93)	.500 (12.70)	1.80 (45.72)	1.672 (42.47)	.1884 (4.78)
VAS 44	2.75 (69.85)	.500 (12)	.625 (16)	1.25 (31.75)	.250 (6.35)	.700 (17.78)	3.30 (83.82)	1.625 (41.28)	.500 (12.70)	1.80 (45.72)	2.375 (60.33)	.188 (4.78)
VAS 48	3.00 (76.20)	.625 (16)	1.000 (25)	1.75 (44.45)	.250 (6.35)	.700 (17.78)	4.00 (101.60)	1.750 (44.45)	.500 (12.70)	2.43 (61.72)	2.625 (66.80)	.250 (6.35)

\*Bore diameters (Dimension B): other than standards shown are available up to the maximum diameter.

\*\*Standard output bore (Dimension BB): other diameters (English and metric), hex sizes or custom configurations are available upon request.

MODEL NO.	THRUST LOAD lbs. (N)	CAPACITY @ 50 RPM		FRICTION SURFACES
		lb-in (Nm)	Watts	
VAS 20	165 (37)	12 (1.36)	6	8
VAS 24	255 (57)	25 (2.82)	15	12
VAS 32	300 (67)	50 (5.65)	30	12
VAS 44	400 (89)	75 (8.47)	43	12
VAS 48	665 (149)	100 (11.29)	55	12



Please note that torque capacities are only guidelines. Higher torques and speeds are possible depending on operating conditions. Consult factory for details.

## QUOTE REQUEST FORM: SEE PAGE 17.

To see how Polyclutch® slip clutches operate, visit [dynatect.com/clutch-video](http://dynatect.com/clutch-video)

# SLIP-EASE | MECHANICAL SLIP CLUTCHES

Utilizes an axial loaded multi-plate design. For applications where space is at a premium and low backlash is required.

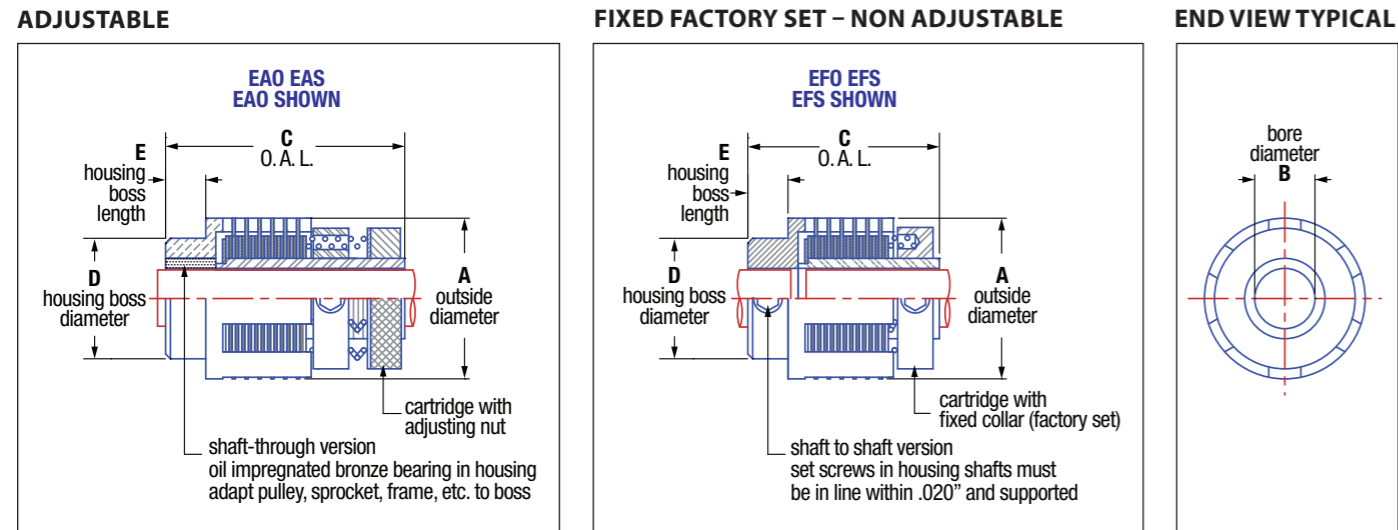

## PART NUMBER EXAMPLES

See page 16 for part number identification.

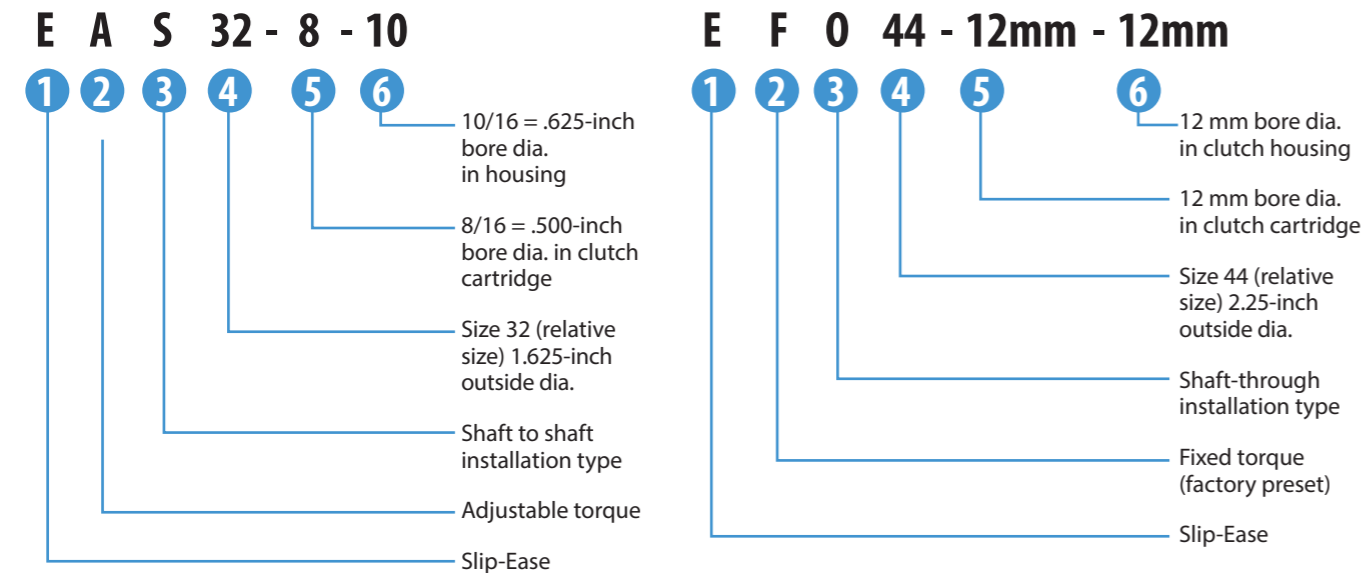

# SLIP-EASE | SPECIFICATIONS

MODEL NO.	A inches (mm)	B* STD. inches (mm)	B MAX. inches (mm)	C inches (mm)	D inches (mm)	E inches (mm)	CAPACITY @ 50 RPM		FRICTION SURFACES
		+.002 / -.000 inches (+.05 / -.00 mm)					lb-in (Nm)	Watts	
EAS 12 & EAO 12	.750 (19.05)	.1875 (5)	.250 (6)	1.25 (31.75)	.562 (14.28)	.188 (4.78)	8.5 (.96)	4.5	8
EFS 12 & EFO 12	.750 (19.05)	.1875 (5)	.250 (6)	1.00 (25.40)	.562 (14.28)	.188 (4.78)	8.5 (.96)	4.5	8
EFS 16 & EFO 16	1.000 (25.40)	.250 (8)	.375 (9)	1.19 (30.2)	.750 (19.05)	.25 (6.35)	16 (1.81)	9	12
EAS 16 & EAO 16	1.000 (25.40)	.250 (8)	.375 (9)	1.50 (38.1)	.750 (19.05)	.25 (6.35)	16 (1.81)	9	12
EFS 24 & EFO 24	1.375 (34.90)	.375 (10)	.500 (13)	2.00 (50.8)	1.000 (25.40)	.38 (9.65)	25 (2.82)	15	12
EAS 24 & EAO 24	1.375 (34.90)	.375 (10)	.500 (13)	2.50 (63.50)	1.000 (25.40)	.38 (9.65)	25 (2.82)	15	12
EFS 32 & EFO 32	1.625 (41.28)	.500 (12)	.625 (16)	1.87 (47.5)	1.375 (34.93)	.50 (12.70)	50 (5.65)	30	12
EAS 32 & EAO 32	1.625 (41.28)	.500 (12)	.625 (16)	2.44 (62.0)	1.375 (34.93)	.50 (12.70)	50 (5.65)	30	12
EFS 44 & EFO 44	2.250 (57.15)	.500 (12)	.625 (16)	1.87 (47.5)	1.625 (41.28)	.50 (12.70)	75 (8.47)	43	12
EAS 44 & EAO 44	2.250 (57.15)	.500 (12)	.625 (16)	2.44 (62.0)	1.625 (41.28)	.50 (12.70)	75 (8.47)	43	12
EAS 52 & EAO 52	3.250 (82.55)	.750 (20)	1.250 (32)	4.00 (101.6)	2.000 (50.8)	.50 (12.70)	150 (16.95)**	85	12

\*Bore diameters (Dimension B): other than standards shown are available up to the maximum diameter.  
 \*\*Maximum capacity is 1,000 lb-in / 112 Nm with design modification. Heat generation should not exceed maximum Watts capacity. Watts = Torque x RPM x Duty Cycle x 0.011

## QUOTE REQUEST FORM: SEE PAGE 17

To see how Polyclutch® slip clutches operate, visit [dynatect.com/clutch-video](http://dynatect.com/clutch-video)

## SLIP-AIRE | PNEUMATIC SLIP CLUTCHES

The Polyclutch Slip-Aire is an air actuated version of the mechanical Polyclutch slip clutch. It has the same long life friction plates, assuring constant torque or tension. With air actuation it can be used to engage/disengage, to vary the torque during operation, or to adjust the torque remotely at any time. Ideal for servo mechanisms, it transmits higher torque levels than comparably sized mechanical slip clutches.

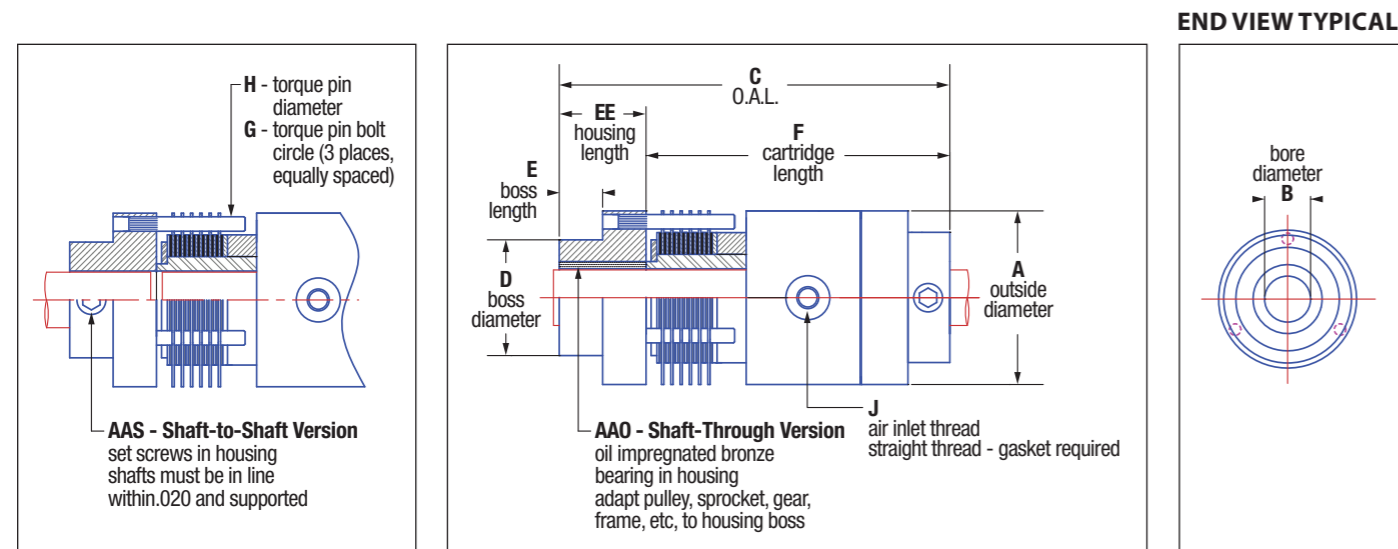

### PART NUMBER EXAMPLES

See page 16 for part number identification.

**A A S 32 - 12mm - 16mm**

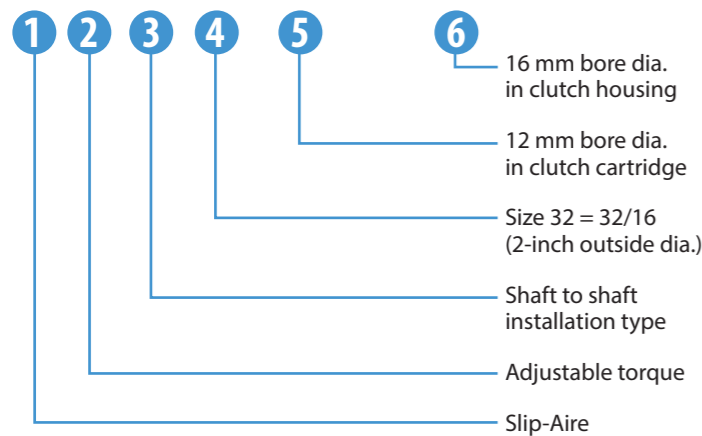

**A A O 20 - 4 - 4**

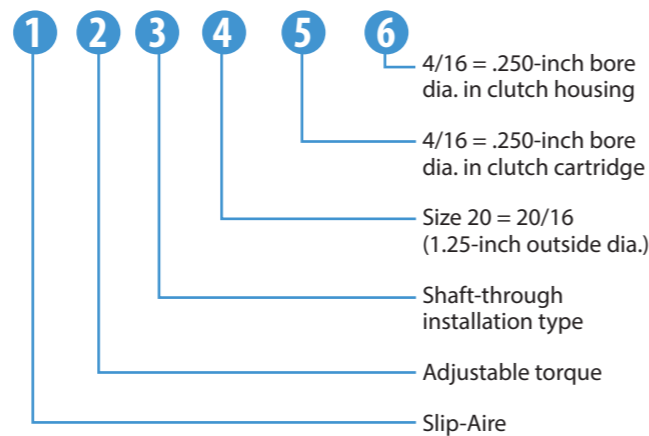

## SLIP-AIRE | SPECIFICATIONS

MODEL NO.	A inches (mm)	B* STD.	B MAX.	C inches (mm)	D** inches (mm)	E inches (mm)	EE inches (mm)	F inches (mm)	G inches (mm)	H inches (mm)	J inches (mm)
		inches (mm)									
AAS 20 & AAO 20	1.25 (31.75)	.250 (8)	.375 (10)	2.50 (63.50)	.760 (19.30)	.25 (6.35)	.50 (12.70)	2.00 (50.80)	1.062 (26.98)	0.94 (2.39)	10-32
AAS 24 & AAO 24	1.50 (38.10)	.375 (10)	.500 (13)	3.38 (85.85)	1.010 (25.65)	.38 (9.65)	.75 (19.05)	2.63 (66.80)	1.312 (33.73)	.125 (3.18)	10-32
AAS 32 & AAO 32	2.00 (50.80)	.500 (12)	.625 (16)	3.63 (92.20)	1.385 (35.18)	.50 (12.70)	1.00 (25.40)	2.63 (66.80)	1.672 (42.47)	.188 (4.78)	10-32
AAS 44 & AAO 44	2.75 (69.85)	.500 (12)	.625 (16)	3.63 (92.20)	1.635 (41.53)	.50 (12.70)	1.00 (25.40)	2.63 (66.80)	2.375 (60.33)	.188 (4.78)	10-32

\*Bore diameters (Dimension B): other than standards shown are available up to the maximum diameter.

MODEL NO.	CAPACITY CONTINUOUS @ 50 PSI* lb-in (Nm)	CAPACITY MAXIMUM @ 100 PSI** lb-in (Nm)	WATTS	FRICTION SURFACES
AAS 20 & AAO 20	12 (1.36)	20 (2.26)	6	8
AAS 24 & AAO 24	25 (2.82)	50 (5.65)	15	12
AAS 32 & AAO 32	50 (5.65)	100 (11.30)	30	12
AAS 44 & AAO 44	75 (8.47)	300 (33.90)	43	12

\*Rated torque for continuous operation at 50 RPM. Torque can be higher or lower depending on actual RPM and duty cycle.

\*\*Maximum torque attainable (at 100 PSI).

### QUOTE REQUEST FORM: SEE PAGE 17

To see how Polyclutch® slip clutches operate, visit [dynatect.com/clutch-video](http://dynatect.com/clutch-video)

# ONE WAY CLUTCHES

## POLYCLUTCH® SHELL-PAK

Right Drive: Shell drives hub clockwise when viewed from extension end of hub.  
Torque capacity 8 lb-in.

Dimension B = 0.250 (Bore Diameter) Dimension D = 0.0625 (Pin Diameter)

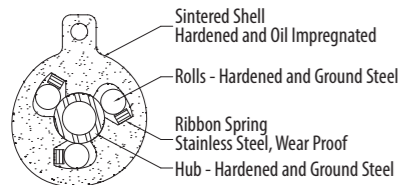

Inside View

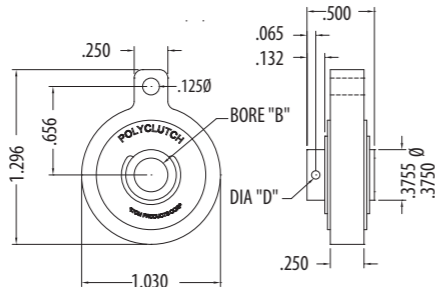

Single Assembly Model HEA Solid Arm

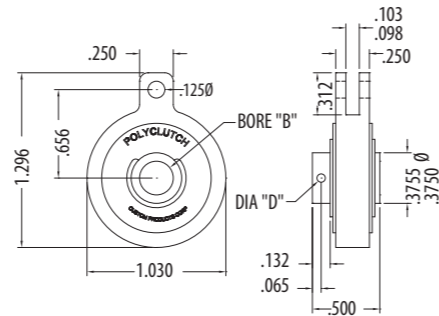

Single Assembly Model HEM Milled Slot in Arm

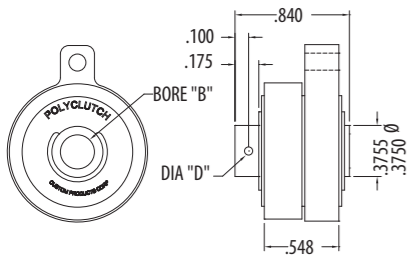

Duplex Assembly all Combinations Available  
Shown with HEO and HEA Single Assemblies Model HEOA

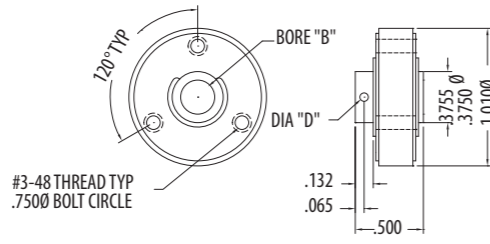

Single Assembly Model HET  
3 Tapped Holes

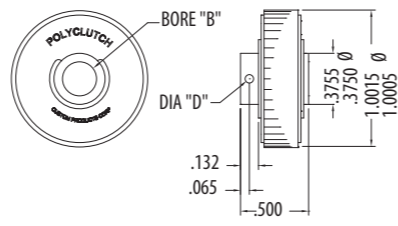

Single Assembly Model HEO  
O.D. Ground for Press Fit

# JAW CLUTCHES

Polyclutch® Jaw type clutches permit simple, reliable phase adjustment, and/or engage-release between a shaft and gear, pulley, roller, etc. The D-Series is knob-operated, the J-Series is lever-operated. Clutch teeth are precision machined from solid steel blanks, 3° tooth spacing (120 teeth) is standard. Alternate spacing available. Polyclutch jaw clutches are stronger than the shaft driving them.



Model Number	A	B	C	D	E	F	P	Q	R	S	KEY
DH 20	1.25	.250	1.87	.562	.39	-	-	-	-	-	-
DK 20	1.25	-	-	.562	.39	.375	.338	.032	.833	.845	#212
DH 32	2.00	.500	2.50	1.252	.75	-	-	-	-	-	-
DK 32	2.00	-	-	1.252	.75	.750	.703	.048	.890	1.470	#606
DJ 20 (Jaws Only)	1.25	.375	1.10	.560	.39	-	-	-	-	-	-
DJ 32 (Jaws Only)	2.00	.750	1.95	1.250	.75	-	-	-	-	-	-

DH CLUTCH - WITH HUB

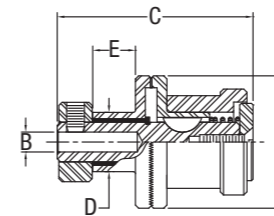

DK KIT - LESS SHAFT

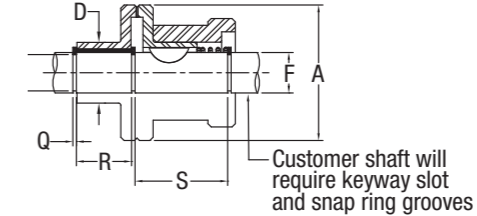

DJ - JAWS ONLY

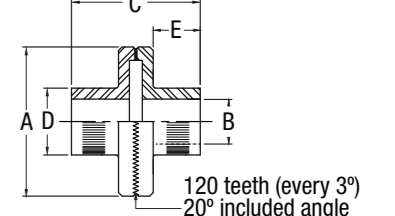

Model Number	A	B	C	D	E	F	P	Q	R	S	KEY
JH 32	2.00	.500	3.37	1.252	.75	.750	-	-	-	-	-
JK 32	2.00	-	-	1.252	.75	.750	.703	.047	.890	1.625	.187 SQ

JH CLUTCH - WITH HUB

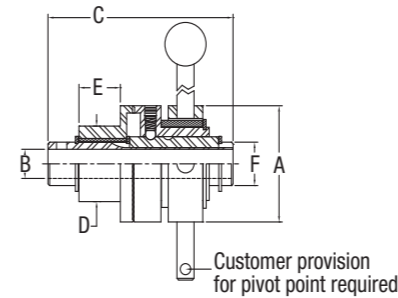

JK KIT - LESS SHAFT

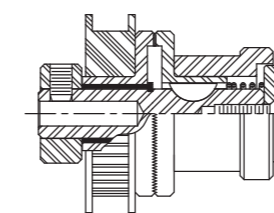
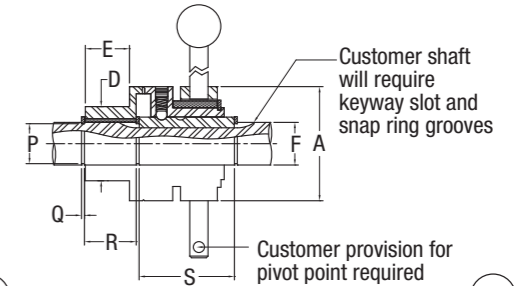

Phase adjustment shaft to pulley  
Pulley pressed onto knurled housing

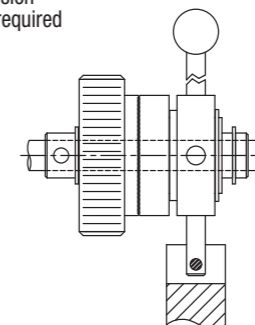

Prevent reversal gear  
Adapted to housing

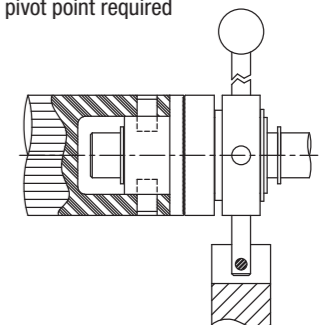

Engage and disengage mechanism  
Drive roll adapted to housing



## SLIP CLUTCH MOUNTING OPTIONS

All Polyclutch® slip clutches perform the basic function of controlling the torque between two elements. They can be supplied as a shaft-to-shaft coupling or a shaft to pulley, gear, or sprocket model. Polyclutch® custom slip clutches can be provided with non-standard bore sizes, keyways, low backlash or higher torque, minus housings and with pulley, gear or sprocket.

Note: To see how Polyclutch® slip clutches operate, visit [dynatect.com/clutch-video](http://dynatect.com/clutch-video).

**FIG. 1** Shaft to Shaft.  
Shafts must be supported and aligned within .010" - .015".

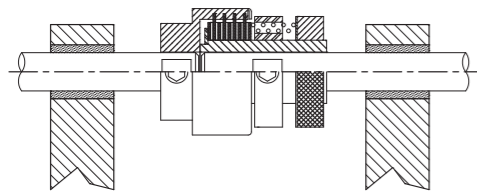

**FIG. 2** Gear/Pulley/Sprocket adapted to housing with knurl, roll pin, cap screws, etc.

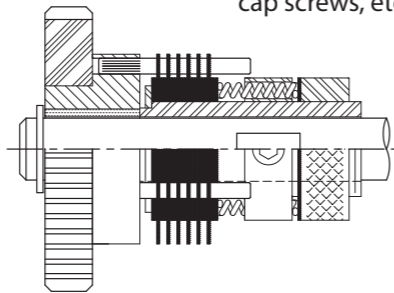

**FIG. 3** Supply or rewind spool adapted to housing with knurl, pin, cap screws, set screw, key, etc.

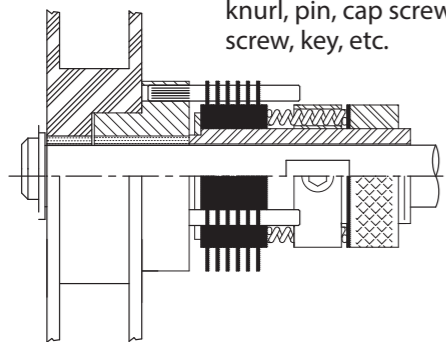

**FIG. 4** Gear/Pulley/Sprocket modified with pins for engagement. Housing is eliminated.

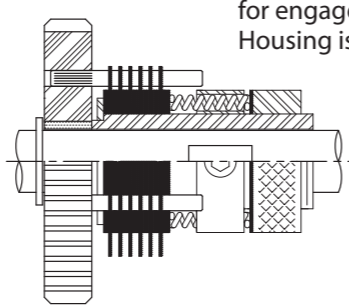

**FIG. 5** Gear/Pulley/Sprocket integrated as part of cartridge.

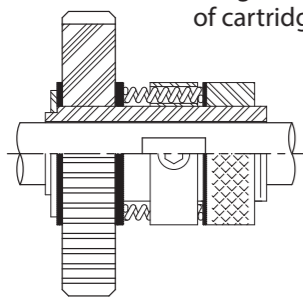

**FIG. 6** Knob adapted to housing knurl, set screw, pin, etc.

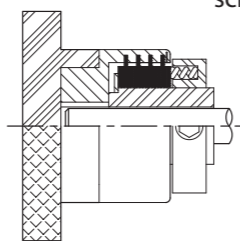

**FIG. 7** Machine frame adapted with cap screws to housing.

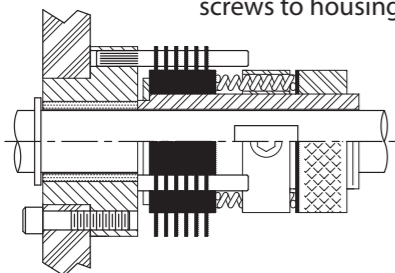

**FIG. 8** Rotary position holder (hinge).

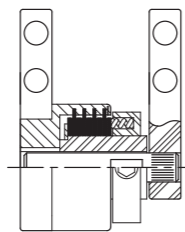

## BUILD A POLYCLUTCH® PART NUMBER

**S A S 24 - 4 - 6**

① ② ③ ④ ⑤ ⑥

**HOUSING BORE SIZE:**

Represented in sixteenths of an inch (6/16"=3/8"). For metric, add MM after bore sizes. (e.g., SAS24-4MM-6MM).

**CARTRIDGE BORE SIZE:**

Represented in sixteenths of an inch (4/16" = 1/4"). For metric, add MM after bore size (e.g., SAS24-4MM-6MM).

**OUTER DIAMETER:**

Generally represented in sixteenths of an inch, please see specifications for exact dimensions.

**INSTALLATION TYPE:**

"S" is shaft to shaft  
"O" is shaft-through for mounting to pulley, gear, sprocket, etc.  
"Y" is cartridge only

**TORQUE SETTING:**

"A" is adjustable torque.  
"F" is factory preset (fixed) torque. Indicate torque value: T= \_\_\_

**TYPE OF SLIP CLUTCH:**

S = Multi-Plate Slipper      P = Single-Plate Slipper      V = V-Series Slipper  
E = Slip-Ease                      A = Slip-Aire (air-actuated)

### STANDARD OPTIONS

Polyclutch slip clutches are designed to cover a wide range of solutions. To help better fit the clutch to your specific application, here is a list of standard options:

- Bore size changes – English (inches) and metric (mm)
- High torque option, accomplished by extra springs – "H" part no. suffix  
– Will increase capacity of standard adjustable slip clutches by 50% (note: removing springs will lower capacity, increase sensitivity)

- Keyways – English and metric – "K" part no. suffix
- Low backlash in Slipper clutch – "UL" part no. suffix
- Heavy inner plates for extra cooling – "D" part no. suffix
- 303/304 stainless steel construction – "Q" part no. prefix
- Two-plate Slipper clutch – "R" version (part no. begins with "R")
- Plastic cover for Slipper and Slip-Aire clutches

### CUSTOMIZED CLUTCHES

If you are looking for something outside of our standard options, our engineers will work with you to help design a clutch for your specific application. Polyclutch® custom slip clutches can be provided with non-standard bore sizes, keyways, low backlash or higher torque, minus housings and with pulley, gear or sprocket.



# POLYCLUTCH® SLIP CLUTCHES

## QUOTE REQUEST FORM

Date Needed By \_\_\_\_\_ Address \_\_\_\_\_  
 Quantity \_\_\_\_\_ City \_\_\_\_\_ State/Prov. \_\_\_\_\_  
 Company Name \_\_\_\_\_ Country \_\_\_\_\_ Zip/Postal Code \_\_\_\_\_  
 Contact Name \_\_\_\_\_ Phone \_\_\_\_\_  
 Email \_\_\_\_\_

### 1. Application Information

Overload Protection       Torque Control (i.e. bottle capping, screwdriver)  
 Constant Tension/Force       Brake  
 Soft Start/Cushioned Stop       Positioning Hinge  
 Other \_\_\_\_\_

Operating Environment (list specific requirements, # corrosives, water, etc.): \_\_\_\_\_

Orientation:  Vertical  Horizontal  
 Temperature Range: \_\_\_\_\_ Type of Equipment: \_\_\_\_\_  
 Other Application Information: \_\_\_\_\_

### 2. Clutch Information

Polyclutch Part Number (if known): \_\_\_\_\_  
 Mechanical Slip Clutch     Pneumatic Slip Clutch     One-Way Clutch     Jaw Clutch     Combination

Torque Range: \_\_\_\_\_  lb-in     Nm  
 Type of Mount:  
 Shaft/Shaft Mounting\*      \*Input Shaft Diameter: \_\_\_\_\_ \*Output Shaft Diameter: \_\_\_\_\_  
 Shaft Through Mounting\*\*      \*\*Input Shaft Diameter: \_\_\_\_\_ \*\*Output Type (gear, pulley, etc.): \_\_\_\_\_  
 Other: \_\_\_\_\_

RPM (at the clutch): \_\_\_\_\_  
 Duty Cycle (percentage of the time the clutch will be in slip condition): \_\_\_\_\_  
 Maximum Space Limitations (envelope size, if limitation exists): \_\_\_\_\_  
 Life Requirements (number of cycles, only if a specification exists): \_\_\_\_\_

### TIPS:

Visit our website for an online version at [dynatect.com/request-for-quote](http://dynatect.com/request-for-quote). If using the fillable PDF version, first save the PDF to your computer, then open up in Adobe Reader, fill out, then save.

## APPLICATION EXAMPLES

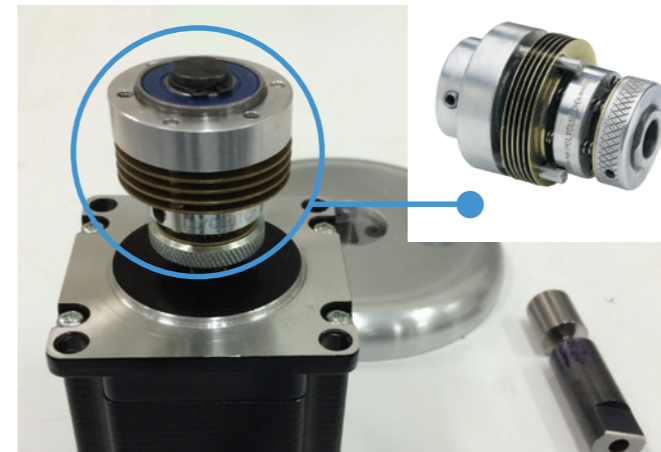

**Dental Tool** - The Polyclutch® slipper provides precision torque control during the manufacturing of dental implants.

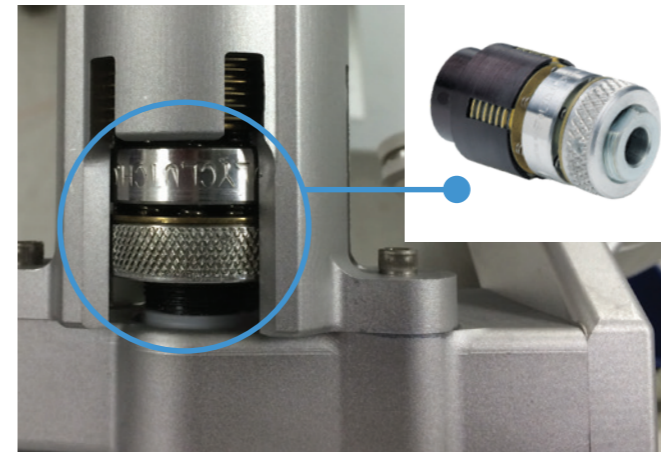

**Surgical Device** - A Slip-Ease clutch is used as a retention hinge on a mounting platform.

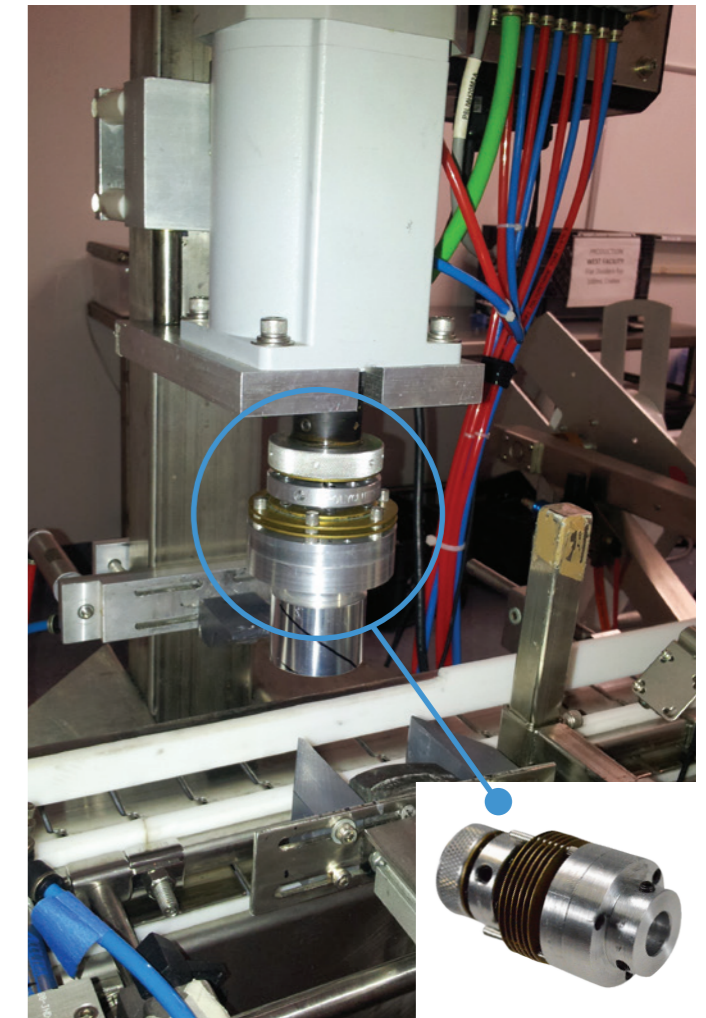

**Capping** - The V-Series slipper is the ideal solution for torque control on capping machines.

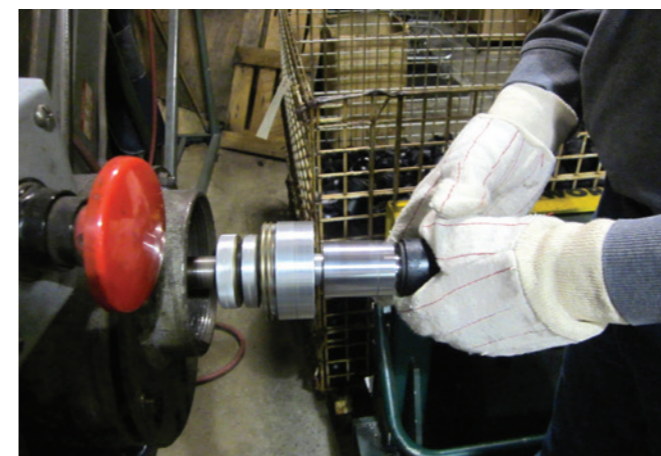

**Mechanical Safety** - The V-Series Slipper provides overload protection and increases operator safety to this manual cutting tool. This mechanical slip clutch limits the amount of torque that is transferred to the cutting tool, making this a safer operation for the user.

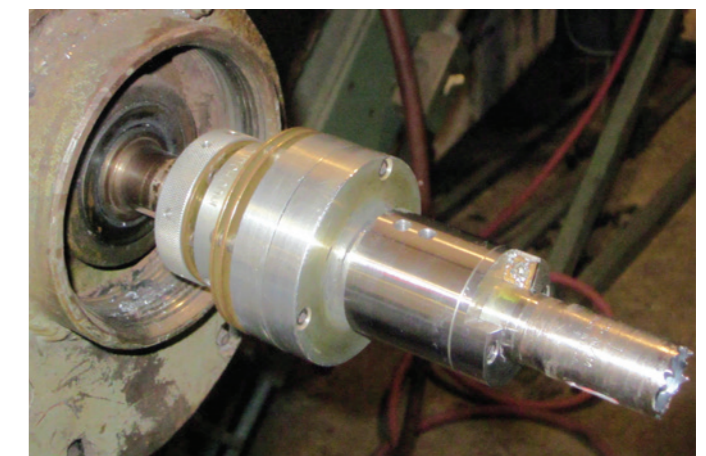

**DYNATECT**<sup>®</sup>  
DYNAMIC EQUIPMENT PROTECTION

***thodacon***<sup>®</sup>

## OTHER PRODUCTS & SERVICES

GORTITE<sup>®</sup>  
BELLOWS, PROTECTIVE  
COVERS, AND DOORS



GORTRAC<sup>®</sup>  
CABLE & HOSE CARRIERS



### THODACON MACHINE TOOL PROTECTION CO LTD

Lu-Ou Road No. 43, Hudai Industrial Park | Bin District, Wuxi 214161 | Jiangsu Province, China  
phone +86 5108 3291 518 | fax +86 5108 3291 598 | email: sales@thodacon.cn | dynatect.com

Dynatect<sup>®</sup> is a proprietary trademark of Dynatect Manufacturing Inc. | ©2021 Dynatect Manufacturing Inc. | DT21-PC-08